

EXAflow

Iniezione nel bordo interno di particolari di piccole/medie dimensioni
 Massimo foro d'iniezione realizzabile Ø 2,5 mm
 Per pesi da 20 a 200 gr. - Specifico per materiali critici quali PC - ABS
 Non è ammesso l'utilizzo con materiali carichi

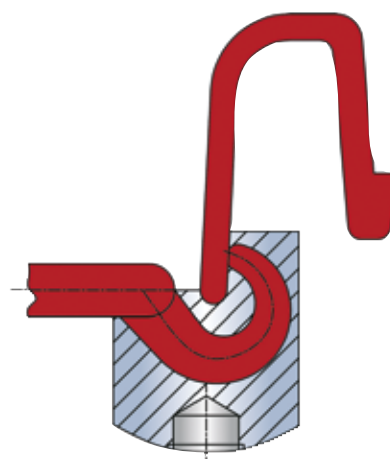

per
 posizione espulsore
 tiracolata vedere
 figura 2
 pagina 4.09

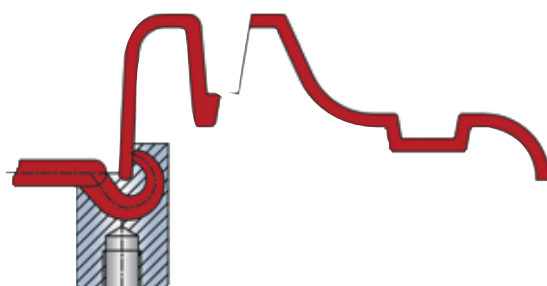
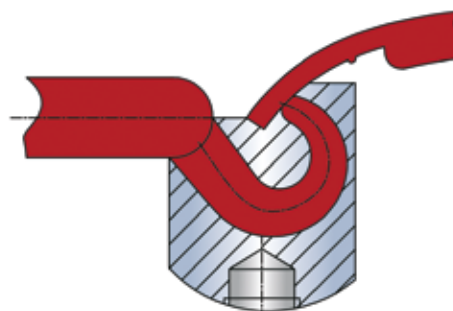
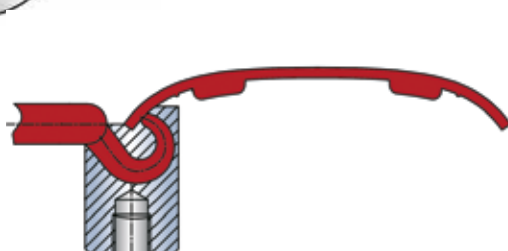
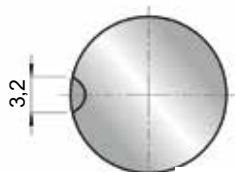
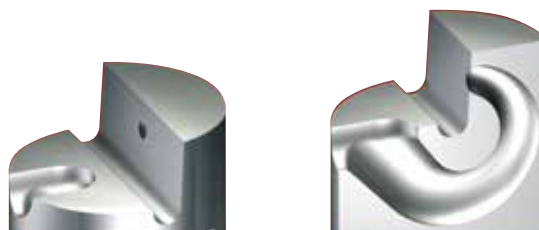
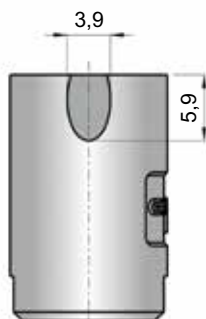
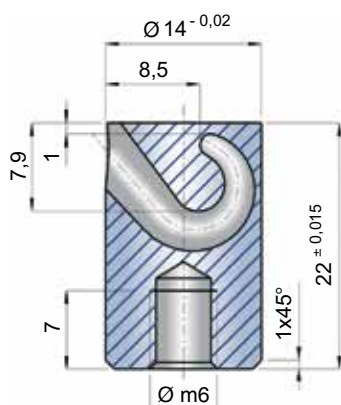